

## Introduction

Lumeter Limited, established in 1978, boasts over four decades as a widely appreciated market leader and innovator in the supply and manufacture of grease pumps, grease guns and agricultural fasteners. Despite the substantial growth since its foundation, the company has proudly remained family-run, serving automotive, agriculture, construction, garage workshop, chemical industries and OEMs.

Lumeter cares about your customers. We deliver that extra personal touch of excellence in customer care that only comes from a family business. Our success lies in listening to our customers and understanding the need to supply robust, durable products that operate under the toughest conditions, striving to continually improve both our products and our service.

## Quality, Production & Innovation

Lumeter has introduced many innovative solutions for specialist handling-equipment of fluids as diverse as grease, oil, diesel, AdBlue, and chemical. Our vast array of dispensing aids includes hose reels, task-specific trolleys, fasteners such as hitch pins, lynch pins and 'R' grips, valves, as well as, barrel-storage tanks and barrel-sump pallets.

In 2015, Lumeter launched an industry-changing range of hand-operated grease guns with a new patented vacuum-barrel system (Patent No. GB 2525503) to great success. The product of several years of research and development, the adaptive greasing-system feeds grease into the high-pressure head unit entirely by vacuum pressure, with the added advantage to the user of clean and easy cartridge loading. The range comprises side-lever varieties, as well as the MULTI GUN™ that gives users a twin-handled grease gun that accepts multiple types of threaded 500g and 400g cartridges, as well as a standard 400g cartridge.

Lumeter is widely recognised as a major supplier and stockist of one of the largest range of lubrication and fuel-handling equipment and accessories in UK and Europe.

We hope you enjoy the systems-driven efforts we make to bring to you the best in design, quality, and supply efficiencies.

## We Serve

- Automotive
- Agriculture
- Construction
- Garage equipment
- Chemical and engineering industries
- OEMs



## Terms and Conditions

Prices are exclusive of Value Added Tax.

Prices available are those ruling at date of despatch - written confirmation upon request.

All prices are ex-works.

Invoices are payable at end of month following invoice date. Title to goods does not transfer to the buyer until payment in full is received.

Non-arrival of goods must be reported within a maximum period of 10 days from despatch, otherwise claims cannot be considered. Invoices are sent separately to facilitate this action.

Claims for shortages or damage must be reported to Lumeter within 24 hours from receipt of goods. Damaged cartons or shortages must be noted on carriers document at time of receipt.

The seller shall not be liable in any way in respect of late delivery howsoever caused, nor shall such failure be deemed to be a breach of contract.

These are abbreviated Terms and Conditions. Full Terms and Conditions are available upon request.

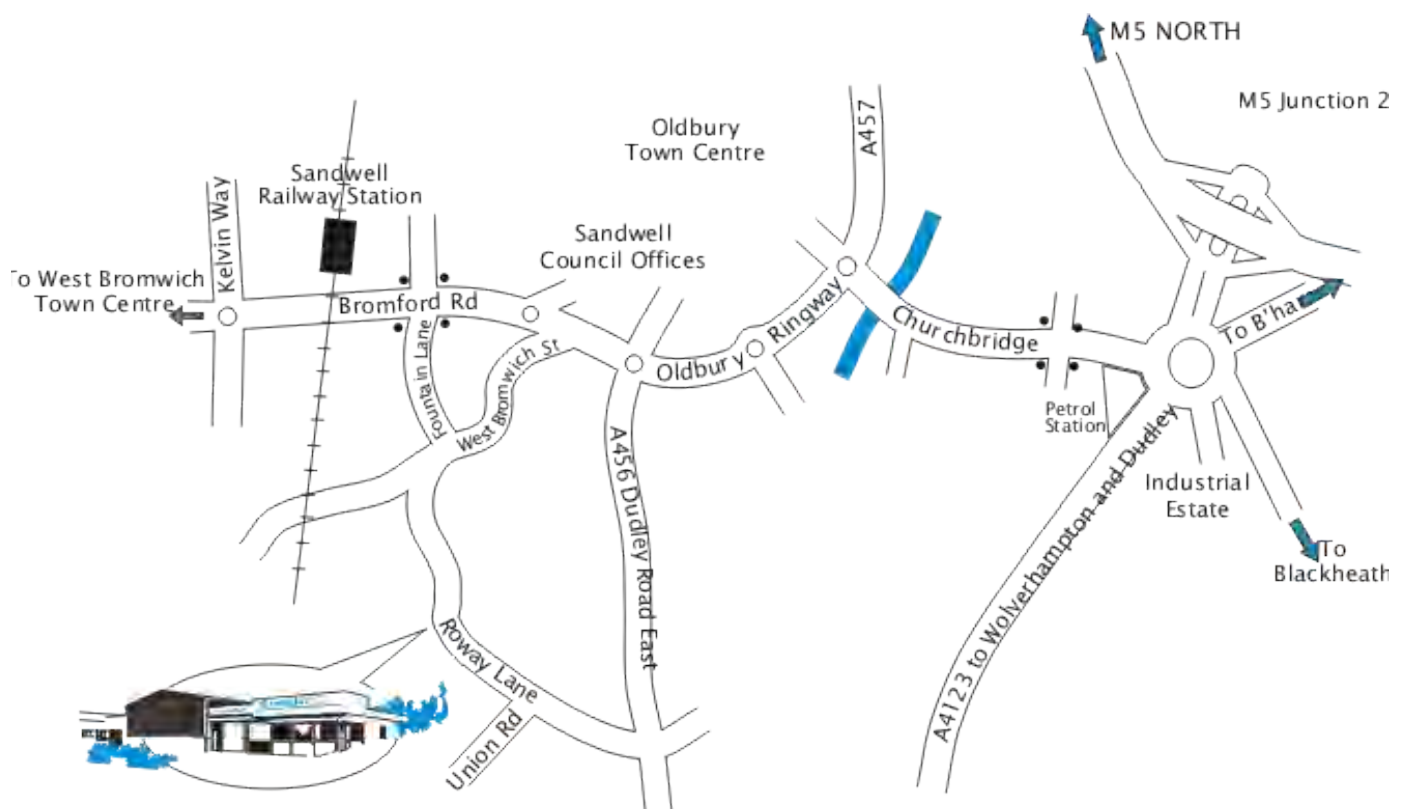

Dispensing Aids	1
Grease Handling	5
Oil Handling	16
AdBlue Dispensing	25
Diesel and Fuel Handling	27
Chemicals and Fluid Handling	35
Hose Reels	39
Storage and Trolleys	41
Waste Handling	45
Fasteners	49
Valves and Fittings	51

Factory & Showroom  
Roway Lane  
Oldbury  
West Midlands  
B69 3EJ  
England



T: +44 (0) 121 544 3090  
[www.lumeter.co.uk](http://www.lumeter.co.uk)  
[sales@lumeter.co.uk](mailto:sales@lumeter.co.uk)



## Guarantee

Our products are guaranteed against defective workmanship and materials for a period of 12 months from date of sale to customer against the following conditions.

If the product has not been abused, we will replace, without charge for labour and components, any component found to be faulty after normal use in accordance with our directions within the warranty period.

Transport costs of the product to us must be paid by the customer. We will charge for the return carriage if the repair is not covered by the warranty.

Any liability incurred by the seller to the buyer is limited to the replacement of the goods, or, at the option of the seller, refund of the price paid by the buyer, and, in particular does not extend to the consequential loss. It is conditional upon the buyer making a written claim to the seller, within 12 months of delivery, setting out the full particulars of such claim, and where possible, returning to us sufficient part of the goods to enable a full examination to be carried out.

Lumeter operate a policy of continuous product improvement such that specifications and drawings/illustrations are for guideline purposes only and products delivered may differ.

## Units Legend

<b>Metres</b>	<b>m (mtr)</b>	<b>Height</b>	<b>H</b>
<b>Millimetres</b>	<b>mm</b>	<b>Minutes</b>	<b>min</b>
<b>Litres</b>	<b>Ltr</b>	<b>Hours</b>	<b>hrs</b>
<b>Centilitre</b>	<b>cc</b>	<b>Volts</b>	<b>v</b>
<b>Kilogram</b>	<b>kg</b>	<b>Amps</b>	<b>A</b>
<b>Length</b>	<b>L</b>	<b>Amps/Hours</b>	<b>A/H</b>
<b>Width</b>	<b>W</b>	<b>Watts</b>	<b>w</b>
<b>Depth</b>	<b>D</b>	<b>Horsepower</b>	<b>hp</b>



### Anti-Spill Funnels

**J8055/6** 6" (150mm) Heavy duty polyethylene with filter and flexispout. Box Qty 36.

**J8055/9** 9" (225mm) Heavy duty polyethylene with filter and flexispout. Box Qty 27.



### Flexispout Funnels

**J8055/SS** 160mm with stainless steel flexispout and filter.

**J8055/160F** 160mm HDPE with plastic flexispout and filter.



### Large Garage Funnel

**J8055/12GF** Black 12" (260 x 170mm) HDPE with universal filter. Box Qty 20.

**J8055/12U** Spare water separator filter.



### Standard Funnels

**J8055/100** 100mm HDPE with hanging facility.

**J8055/150** 150mm HDPE with hanging facility.

**J8055/195** 195mm HDPE with hanging facility.

**J8055/250** 250mm HDPE with hanging facility.



### 3 Piece Large Funnel Set

**J8055/20SE** 100/150/250mm HDPE. Box Qty 20.



### 4 Piece Small Funnel Set

**J8055/SET4** 55/75/100/120mm HDPE. Box Qty 20.



### Offset Spout Funnel

**J8055/OFF** 150mm HDPE with strainer.



### Safety Funnel with Lid

**J8055/SAF** 250mm HDPE with 2" BSP male diecast adaptor.

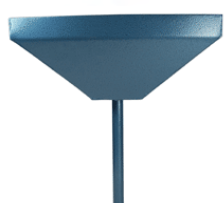

### Heavy Gauge Steel Funnel

**J8065/25** 259 x 216mm with steel mesh filter with 1 1/4" O/D tube.

**J8065/205** 406 x 259mm with steel mesh filter with 2" O/D tube.



### Standard Oil Measures

**J8056/1.5** 1.5Ltr Heavy duty polyethylene. Box Qty 24.

**J8056/5** 5Ltr Heavy duty polyethylene. Box Qty 18.



### Flexispout Oil Measures

With lid and spout cap.

**J8057/1N** 1Ltr Heavy duty polyethylene. Box Qty 24.

**J8057/2N** 2Ltr Heavy duty polyethylene. Box Qty 24.

**J8057/3N** 3Ltr Heavy duty polyethylene. Box Qty 18.

**J8057/5N** 5Ltr Heavy duty polyethylene. Box Qty 18.

**J8057/SF** Small spare flexispout for J8055/4/6 & J8057/1N/2N/3N.

**J8057/LF** Large flexispout for J8055/9 & J8057/5N.



### Measuring Jugs

**J8060/J5** 5Ltr HDPE

**J8060/J3** 3Ltr HDPE

**J8060/J2** 2Ltr HDPE

**J8060/J1** 1Ltr HDPE

**J8060/J05** 0.5Ltr HDPE

**J8060/J025** 0.25Ltr HDPE



### Plastic Drain Bowls

**J2250** 14Ltr Black c/w handles and pourer.



**J2253** 6Ltr Red c/w pourer and filter rest.



### Diecast Zinc Drum Tap

**J4175** 3/4" BSP Lockable.



### Polypropylene Drum Tap

**J4174** 3/4" BSP White plastic (not lockable).

**J4176** 3/4" BSP. Lockable.

**J4176SE** As above but with 2" Trisure male converter. 3/4" Poly Tap.



### Solid Brass Drum Tap

**J4176/B** 3/4" BSP. Lockable.

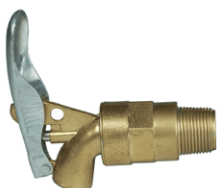

### Self Closing Drum Tap

**J4177** All metal - 3/4" BSP. Lockable.



### Polyethylene Drum Tap

**J4176/G** 2" BSP.

**J2654/TS** Converter - Trisure to 2" BSP (F). For using J4176/G with plastic 205Ltr barrels.



### Aeroflo Tap

**J2650/R** 61mm. Fits male threaded 25Ltr drums. Self venting for smooth splash free flow.



### Jumbo Portable Transfer Pump

Suitable for diesel, gas oil, light oils, hydraulic/brake fluid and anti-freeze.

**A1004** Supplied with 2 x 1m of hose for inlet and outlet.



### Suction Gun

**J0150** 500cc capacity. Supplied with 270mm flexitube.

**J0100** 1000cc capacity. Supplied with 270mm flexitube.



### Steel Oil Cans

Manufactured from "Rust proofed" coated steel.

**J5000/2** 200cc with rigid and flexi spout. Steel pump.

**J5000/3** 300cc with rigid and flexi spout. Steel pump.

**J5000** 500cc with rigid and flexi spout. Steel pump.

**J5000/5** 500cc with rigid and flexi spout. Brass pump.

**J5000/10** 1000cc with rigid and flexi spout. Brass pump.



### Polyethylene Oil Can

**J5001** 500cc polyethylene body with rigid and flexi spout.



### Plastic Sprayer Bottles

**J0001** 750cc with chemical resistant head.



### Brake Cleaner & Chemical Pressure Sprayers

**J0002** 1.5Ltr. Box Qty 12.

**J0002/WB** 1Ltr with brass nozzle. Box Qty 12. (Illustrated).



### Sealant Gun

**J0003** Metal construction. Suitable for 310 and 400ml cartridges.



### Steel Jerry Cans

**J0007** 10Ltr heavy duty steel jerry can. Box qty 6.

**J0004** 20Ltr heavy duty steel jerry can. Box qty 4.



**J0008R** Non-glug rigid spout for steel jerry can - metal.

**J0014** Flexible plastic spout for steel jerry can.

**J0004/SEAL** Seal for lid of steel jerry can.





### Grease Types

Our Grease Guns and Pumps are designed to handle most of the popular multipurpose greases to NLGI - No.2 specification made with light to medium base oil viscosities. However, with greases for special applications, which may have high viscosity base oils and/or special additives, problems may be encountered. If so, the question of pumpability should be referred to the appropriate grease manufacturer.

### Multi Gun Range®™

Patented Grease Gun Barrel Assembly: Patent GB 2525503

Our new comprehensive range of Grease Guns are fitted with our Patented Vacuum Barrel System. By using the vacuum principle the grease is evacuated from the cartridge to the Grease Gun Head. The inherent problems of loading grease cartridges into conventional spring operated grease gun are a thing of the past. The quick, simple and clean method can be used with any standard 400g cartridges to DIN1284 standards, and for threaded cartridges 500g small dia threaded cartridge and the 400g threaded cartridge.

### Benefits

- Clean easy loading
- Simple to use
- Enables the user to buy cartridges from any source for evacuation of the grease
- Safety - no possibility of trapping fingers when spring pressure released
- Gun can be store loaded thereby avoiding oil leakage with spring pressure grease guns



#### A1036MG Twin-handled Multi Gun®

(Dispenses Standard DIN1284/ 500g/400g Threaded Cartridges)

Supplied with

- ♦ Large adapter for the Patented Barrel Assembly for Standard DIN1284 Cartridges
  - ♦ 5 x Follower Seals to enable a supply of loaded cartridges to be available (replacement seals are available at a nominal cost)
  - ♦ 18" Spring Guard Hose & 4 Jaw coupler
  - ♦ Hose Parking to prevent contamination
  - ♦ Threaded head for 500g cartridge
  - ♦ Adapter for use with the large dia threaded 400g cartridge
  - ♦ Security ring (for use with screw thread cartridges)
  - ♦ Zinc plated barrel and handles with plastic non-slip grips
- Supplied in a printed retail box with full operating instructions

#### A1038 Side-lever grease gun

(for Standard Cartridges)

This gun can use Standard Cartridges DIN1284 with the Patented Barrel Assembly

Supplied with:

- ♦ 5x Follower Seals
- ♦ Zinc plated barrel and grey head/handle assembly with a plastic grip
- ♦ 8" Hose and 4 Jaw Coupler
- ♦ Supplied in a printed retail box with full operating instructions



#### A1036F Follower seals

Pack of 5 replacement follower seals



### Major Pistol-Grip Grease Gun

**A1024R** 500cc bulk fill or 400g cartridge. With straight extension tube and 4 jaw coupler.

Dual purpose greaser. Fitted with filler nipple/air release.





**J0515/QC** 6-Jaw quick release grease coupler

Light Lever and uncoupling design-74mm in length and 30mm in height. Non-removeable hardened coupling with 6 integral jaws.. No splash back when disconnecting. No waste. Suitable for Hand, Battery or Air Operated Guns and Pumps. Working pressure: 10,000psi/690 bar. Max Bursting Pressure: 15,000psi/1034 bar. No damage to seal even after several hundred uses. Fits all BSI Grease Nipples DIN 171412 SAE & Metric Zerk fittings



### Heavy Duty Side-Lever Grease Guns

Develops up to 10,000 psi - to DIN 1283. Screwed end cap for easy cleaning, quick discharge of empty cartridge. Grease capacity 500cc bulk fill or 400g grease cartridge. Bulk filler nipple/air release, Crank and 4 Jaw Coupler. Precision machined 10mm piston for higher output/stroke. Extra strong spring. Long handle and barrel for extra leverage. Plastic handle grip and knurled barrel for a firm hold. Individually retail boxed with instructions.



**A1019B** Premium quality with "Ram Rod" system. Steel Head. Blue/Black.

**A1023R** Professional Gun with steel head. Red/Black



### Varimatic Hand Compressor Grease Gun

This grease gun has a valve in the head to allow grease to enter the chamber even with very short handle movements. "For limited space situations and extra pressure." Fitted with filler nipple/air release. Cast iron head.

**A1033** Side-lever grease gun c/w J0515BHD 4-jaw. Chrome-plated



### Twin Handled Grease Gun

**A1034M** For 500g Fuchs cartridges, c/w 12" Nylon Hose and 4-jaw and hose park

**A1034MSE** As above but with adapter for lube shuttle.



### Air Operated Grease Gun

Operates from air supply of max. 8 bar. Can be coupled up to a vehicle compressor of 3cfm min. air volume. Continuous shot.

**J0181** Automatic. Runs continuously when trigger is held open.



### Cortalube Grease Gun

Cast-head variable stroke pistol grip with extendable arm for use as side-lever. Slip resistant grip

**A1026/HDH** Supplied with cranked tube, 12" rubber hose and HD couplers.



### 12v Rechargeable Grease Gun Kits

Supplied in a carrying case, with charger, two batteries, shoulder strap, 400mm grease hose with 4 jaw coupler. Air release valve.

**A2000** 12V Cordless Grease Gun, 500cc bulk fill or 400g cartridge. Max 6000 psi.

**A2000HD** Heavy Duty 12V Grease Gun, 500cc bulk fill or 400g cartridge. Max 8000 psi

**A2000/LITH** 14.4V Cordless Grease Gun with Lithium Battery, 500cc bulk fill or 400g cartridge.

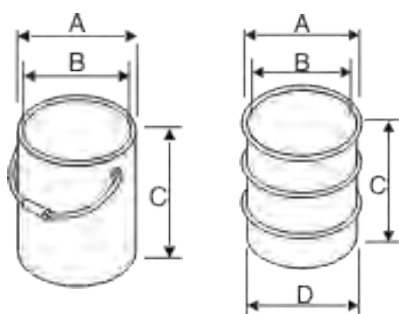

### Greasing System - Keg Sizes for Hand & Airomatic Greasing

Our Greasers are designed to suit grease containers and kegs for most countries. In cases of doubt, please specify dimensions **A, B & C** of grease containers when purchasing. The net contents of the container should also be advised.

**A**=Outside diameter of keg rim, **B**=Inside diameter of keg, **C**=Inside depth of container, **D**=Outside diameter, **T**=If tapering keg - internal diameter at top and bottom.

### Heavy Duty 'High Pressure' Direct-on-Nipple Greasers

All greasers are supplied with rubber-edged follower plates as standard to reduce grease vortexing and cavitation in the containers. 1.5 metres of high pressure rubber flexihose (min bend radius 35mm) and 4 jaw coupler with cranked extension tube. Pressure exceeds 6000psi.

- J4512SE** For 12.5kg grease kegs with extra strong lid. Heavy-duty H.P. greaser.
- J4515SE** For 12.5kg grease kegs. Economy model\*.
- A1058PSE** For 18kg plastic grease kegs.
- A1021SE** For 20kg taper drum H.P. greaser.
- A1098SE** For 25kg grease kegs.
- J4550SE** For 50kg grease kegs. Major greaser.

\*Note: Economy version with pressed round lid. (2800psi). Light duty use, the handle will lock when void is full.



J4512SE

### Low Pressure Grease-Gun Filler Pump

High volume pump to fit grease guns through a filler nipple. Supplied with lid and rubber-edged follower plate to reduce the grease vortexing and causing cavities in the keg.

- J9528SE** For 12.5kg grease kegs. Fills through filler nipple on grease gun.
- J9551SE** For 50kg grease kegs. Fills through filler nipple on grease gun.

**Note:** We can supply systems for any keg size.

### Bulk Filler Pump for Grease Transfer

High volume output with 1.5m of 3/4" (19mm) hose. For transfer of grease or bulk filling grease guns. Supplied with lid and rubber-edged follower plate as standard, to reduce the grease vortexing and causing cavitation in the containers (unless otherwise stated).

**Note:** As J9528SE with hose on outlet

- J9515SE** For 12.5kg grease kegs.
- J9518SE** For 18kg grease kegs.
- A1082SE** For 50kg grease kegs.
- J9512/BR180** \*Pump only for 180kg grease drum with 3/4" O/D pipe for hose.

\*Accessories for 180kg pump: lid, follower plate, hose (specify length).



J9528SE



J9515SE/CF

### Auto-Chassis Grease Filler Pump

High volume output (13g per stroke) for filling auto chassis lubrication system reservoirs. Supplied with 1.5m of 3/8" (9mm) hose and 1/4" BSP male end fitting for your quick release connector and lid. Follower plate supplied as an optional extra if required.

**J9515SE/CF** For 12.5kg grease kegs. Economy version with pressed round lid.

**J9515SE/CFF** For 12.5kg grease kegs. With female fitting J2252/CFF.

**A1067SE/CF** For 18/20kg grease kegs.

**A1068SE/CF** For 25kg grease kegs.

**A1031SE/CF** For 50kg grease kegs.

**Plastic Grease Kegs** - Please contact us for a quotation for your required specification

Dry-Break Filler Connectors:

**J2252/CFM** Male coupler 1/4" BSP female threads.\*

**J2252/CFF** Female coupler 1/4" BSP female threads.\*

\*Note: The female coupler fits most male fillings on chassis systems. (ISO 'B' Type).

### Auto-Chassis High-Volume Grease Filler Pump

Dispenses 75g of grease per stroke (max pressure 500psi). Heavy duty industrial quality grease dispensing designed for automatic chassis greasing systems where greater volume per stroke is required. Supplied with lid and rubber-edged follower plate as standard to reduce the grease vortexing and causing cavitation in the keg, as well as male-female dry break connectors 1/4"BSP threads.



J9513

**J9513** For 12.5kg grease kegs (up to NLGI 3)

- ♦ Solid cast-iron head
- ♦ Steel pump handle
- ♦ Solid steel drum cover with lift handle
- ♦ A rubber-lined follower plate
- ♦ Brass piston rings
- ♦ Two-position handle makes it convenient for use with light and heavy greases
- ♦ Fully sealed to prevent contamination
- ♦ For grease up to NLGI 3

### Greaser Spares

**A1096SE** HP Greaser Spares Kit - Internal seals, 'O' rings, coupler and HP valve.

**J4512/SEALS** Seals and 'O' ring kit.



## Rubber-Edged Follower Plate (Also for use with Air Operated)

**JL4220R** For use with 12.5kg Midi Greasers

**J9545/6SE** For use with 18kg Greasers.

**J9545/6TSE** For use with 18kg Taper kegs.

**J9545/9SE** For use with 25kg Greasers.

**J9545/9TSE** For use with 25kg Taper kegs.

**JL4222R** For use with 50kg Major Greasers.

**M8065** For use with 60kg Greasers.

**M8066** For use with 180kg Greasers.

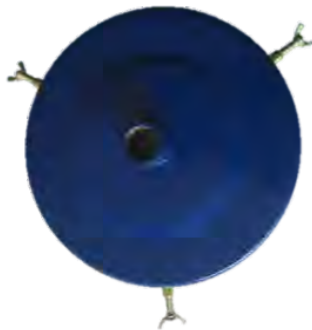

## Robust Steel Lid

**J4503/7SE** For use with 3 & 5kg Mini Greasers. (Hex)

**J9546/2A** For use with 12.5kg Midi Greasers. (Round)

**J9546/3SE** For use with 18/20kg Greasers. (Hex)

**J9546/4SE** For use with 25kg Greasers. (Hex)

**J9546/1SE** For use with 50kg Major Greasers. (Round)

**J9546/180SE** For use with 180kg Greasers. (Round)



## Flexihose (Minimum bend radius for HP hose 35mm) **NB: Not to be used for air-operated**

**J0108** 8" (200mm). Nylon Burst Pressure 1000 Bar 1/8" BSP male end fittings.

**J0108R** 8" (200mm). Rubber Burst Pressure 1000 Bar 1/8" BSP male end fittings.

**J0112** 12" (300mm). Nylon Burst Pressure 1000 Bar 1/8" BSP male end fittings.

**J0112R** 12" (300mm). Rubber Burst Pressure 1000 Bar 1/8" BSP male end fittings.

**J0118** 18" (450mm). Nylon Burst Pressure 1000 Bar 1/8" BSP male end fittings.

**J0118R** 18" (450mm). Rubber Burst Pressure 1000 Bar 1/8" BSP male end fittings.

**A1036H** 18" Hose with Spring Guard & 4 Jaw Coupler.



## Time Savers Snap-On Flexihose

**NB: Not to be used for air-operated**

**A1006SE** 8" (200mm) Nylon. 1/8" BSP c/w 4 jaw coupler.

**A1027SE** 8" (200mm) Rubber. 1/8" BSP c/w 4 jaw coupler.

**A1008SE** 12" (300mm) Nylon. 1/8" BSP c/w 4 jaw coupler.

**A1028SE** 12" (300mm) Rubber. 1/8" BSP c/w 4 jaw coupler.

**A1013SE** 18" (450mm) Nylon. 1/8" BSP c/w 4 jaw coupler.

**A1029SE** 18" (450mm) Rubber. 1/8" BSP c/w 4 jaw coupler.



## High Pressure Flexihose

**NB: Not to be used for air-operated**

**J4500/12** 1.5m with 1/8" BSP male end fittings. Burst pressure 1000 Bar.

**A1015SE** 3m with 1/8" BSP male end fittings. Burst pressure 1000 Bar

## High Pressure Flexihose Kit

**NB: Not to be used for air-operated**

**A1014SE** 1.5m, 1/8" BSP with cranked extension tube and 4 jaw coupler. (Illustrated).

**A1016SE** 3m, 1/8" BSP with cranked extension tube and 4 jaw coupler.



### Airomatic Greasing Systems - Technical Data

Airomatic greasers are suitable for use with multipurpose greases to NLGI - No.2 specification made with light to medium base oil viscosities. However, with greases for special applications, which may have high viscosity base oils and/or special additives, problems may be encountered. If so, the question of pumpability should be referred to the appropriate grease manufacturer.

Power source is by highly efficient trouble free airo-motors of proven design. Operating pressure 3.5 bar minimum to 8 bar maximum. For extended operating life we recommend pressures of 6 bar in conjunction with filtered and lubricated air lines. See Lumeter Air Management System code: M5511.

**Safety Warning:** 100:1 ratio not to be used with hand held equipment.

**Note:** Ensure only air operated grease flexihoses are used with this equipment.

Product Code	M4018L3	M4020	M4060L3	M4080	M4045	M4035	M4019	M4061	M4081
Ratio	50:1	50:1	50:1	50:1	5:1	5:1	100:1	100:1	100:1
Maximum Line Pressure - bar	400	400	400	400	40	40	800	800	800
Delivery Capacity - kg/min	1.4	1.4	1.4	1.4	5	5	0.7	0.7	0.7
Shank Length - cm	42	42	75	95	95	50	38	75	95
External Shank Dia. - mm	28	28	28	28	40	40	28	28	28
Suitable for kegs - kg	12.5	18-30	50-60	180	180	STUB	12.5	50	180
Air Inlet/Grease Outlet	1/4	1/4	1/4	1/4	1/4 1/2	1/4 1/2	1/4	1/4	1/4
Application	Hand Held			Transfer			Special Applications		

### Air-Operated Greaser Kit

Pump complete with lid, follower plate, 4m hose and accessories ready for fitting to your grease keg.

**M4018L3** For 12.5kg grease kegs. 50:1.

**M4020/18SE** For 18kg grease kegs. 50:1.

**M4020/18PSE** For 18kg plastic kegs. 50:1.

**M4020/20SE** For 20kg grease kegs. 50:1.

**M4020/25SE** For 25kg grease kegs. 50:1.

**M4060L3** For 50kg grease kegs. 50:1.

**M4080KIT** For 180kg grease drums. 50:1.

**Plastic Grease Kegs - Contact us for a quotation**

### Air-Operated Greaser Kit with Air Management System

Pump complete with lid, follower plate, 4m hose and accessories ready for fitting to your grease keg, complete with Air Management System.

**M4018L3KIT/AIR** For 12.5kg grease kegs. 50:1.

**M4060L3KIT/AIR** For 50kg grease kegs. 50:1.

**M4080KIT/AIR** For 180kg grease drums. 50:1.

### Air-Operated Greaser Kit Complete with Trolley

Pump complete with lid, follower plate, 4m hose and accessories ready for fitting to your grease keg, complete with Air Management System and Trolley. (As illustrated).

**M4018L3KIT/COMP** For 12.5kg grease kegs. 50:1.

**M4060L3KIT/COMP** For 50kg grease kegs. 50:1.

**M4080KIT/COMP** For 180kg grease drums. 50:1. With 4 Wheel Trolley (M4388).



**NB:** We can supply systems for any keg size.



### Air Management System

This compact system combines pressure regulator with filter, lubricator and gauge. It optimises the efficiency and the life of the pumps when in regular use, also preventing the seizure of moving parts. (Ideally should be installed next to pump).

**M5511** Air Management System

**M5511/1** Gauge - Air Management System.



### Grease Control Gun

1/4" BSP (Male) Inlet.

**M8092** Complete with 'Z' swivel, cranked tube & hydraulic coupler. (Illustrated).

**M8092/KIT** Complete with 'Z' swivel, cranked tube, hydraulic coupler & 12" hose.

**M8082** Gun only with cranked tube & hydraulic coupler.

### 'Z' Swivel Connection

**M8090** 1/4" BSP Male & Female ends. (also illustrated with gun).

### Straight Swivel

**M8091** 1/4" BSP Male & Female ends. Useful accessory for pump body outlet.

### Airomatic Grease Delivery Hose

Working pressure 415 bar/burst pressure 1660 bar.

**J0182/4** 4m with 1/4" BSP Male/Female end fittings.

**J0182/5** 5m with 1/4" BSP Male/Female end fittings.

**J0182/10** 10m with 1/4" BSP Male/Female end fittings.

**J0182/15** 15m with 1/4" BSP Male/Female end fittings.

**J0182/20** 20m with 1/4" BSP Male/Female end fittings.

### High Pressure Rubber Grease Flexihoses

Use with air operated grease control gun. Working pressure 415 bar/burst pressure 1660 bar.

**J0183/R** 9" (200mm).

**J0184/R** 12" (300mm).

**J0185/R** 18" (450mm).

### Steel Lids for Airomatic Greasers

**M8050** For use with 12.5kg grease kegs. (Round)

**J2280/18SE** For use with 18/20kg grease kegs. (Six sided as illustrated).

**J2280/25SE** For use with 25kg grease kegs. (Six sided as illustrated).

**M8053** For use with 50kg grease kegs. (Round).

**M8056** For use with 180kg grease kegs. (Round).

\*Note: When ordering lid only, specify diameter of shaft.

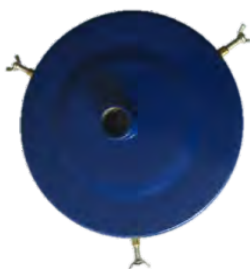



## 4-Jaw Coupler

**J0515** 1/8" BSP.

**J0515HD** Heavy duty 1/8" BSP.



## Push On Connector

**J0523** 1/8" BSP.

**J0501** 8mm.



## Pointed Connector

**J0522** 1/8" BSP.

**J0522/L** 1/8" BSP. Long Pointed



## Cranked Steel Rigid Feed Tube

**J0520** Tapered 1/8" BSP.



**J0518SE** Tapered 1/8" BSP c/w hydraulic coupler.



## Straight Steel Rigid Feed-Tube

**A1059/12** 12" (300mm).

**A1059/18** 18" (450mm).



## Swivel Connection for Flexihose

**J0512** 1/8" BSP



## Standard Filler Nipple

**J0521** 1/8" BSP Bright zinc plate finish.



## Universal Swivel Button Head Coupler

**J0514** 1/8" BSP for standard BH nipple.



## Button Head 'Slide-On' Coupler

**J0509** 1/8" BSP for standard BH nipple.



## Button Head 'Hook-On' Coupler

**J0510** 1/8" BSP for standard BH nipple.



## Giant Button Head 'Hook-On' Coupler

**J0508** 1/8" BSP for 22mm BH nipple.





Snap-On Handy Greasing Extension

**A1020/R** 1/8" BSP.



Snap-On Right Angled Coupler

**A1050SE** 1/8" BSP.



Snap-On Concave Coupler

**A1051SE** 1/8" BSP.



Snap-On Pointed Nozzle Coupler

**A1052SE** 1/8" BSP.



Snap-On/Hook-On Coupler

**A1053SE** 1/8" BSP.



Snap-On/Slide-On Coupler

**A1054SE** 1/8" BSP.



Standard Swivel Snap-On Button Head Coupler

**A1055SE** 1/8" BSP.



Snap-On Giant Button Head Coupler

**A1056SE** 1/8" BSP.



Snap-On Rigid Extension with Coupler

**A1057SE** 1/8" BSP.



Fine Pointed Nozzle Snap-On Coupler

**A1060/50SE** 1/8" BSP. 50mm x 3.8mm



Steel Hexagon Joint

**J0517** 1/8" BSP Internal thread.

### Grease Nipples

Supplied in units of 100 (minimum quantity 100 pieces per size).

- Steel case hardened to prevent wear.
- Batch tested to 8000psi.
- Zinc plated and fully chromated.
- To BSI 1418/DIN71412/SAE J534/J15B1574

Y = Available

METRIC	Straight	45 Angle	90 Angle	Button	Long Type
6 x 1	Y	Y	Y	Y	-
8 x 1	Y	Y	Y	-	-
8 x 1.25	Y	Y	Y	Y	-
10 x 1	Y	Y	Y	-	-
10 x 1.5	Y	Y	Y	Y	-
12 x 1.5	Y	Y	-	-	-
<b>BSP</b>					
1/8"	Y	Y	Y	Y + Brass	-
1/4"	Y	Y	Y	Y + Brass	-
<b>BSF</b>					
1/4"	Y	Y	Y	-	-
5/16"	Y	Y	-	-	-
3/8"	Y	-	-	-	-
<b>UNF</b>					
1/4"	Y	Y	Y	-	15/16"
5/16"	Y	Y	-	-	-
<b>AMERICAN PIPE</b>					
1/8"	Y	Y	-	-	-
<b>DRIVE FIT</b>					
3/16"	Y	-	-	-	-
1/4"	Y	-	-	-	-
5/16"	Y	-	-	-	-
6mm	Y	(Also Concave)	-	-	-



### Stainless Steel Grease Nipples

METRIC	Straight	45 Angle	90 Angle	Button	Long Type
6 x 1	Y	-	-	-	-
8 x 1	Y	-	-	-	-
10 x 1	Y	-	-	-	-
<b>BSP</b>					
1/8"	Y	-	-	-	-
1/4"	Y	-	-	-	-



### Push Grease Gun

**J0330** 60cc with push on connector. Can be used with oil above SAE30.

**J0334** 150cc with push on connector. Can be used with oil above SAE30.

**J0336** 300cc with push on connector. Can be used with oil above SAE30.



### Grease Nipple Extension

**GNHEX1/8BSP** 1/8" BSP male/female 23mm length.



### Grease Nipple Boxes

**J9130** 150 Assorted Imperial Straight and Angled (BSP/BSF/UNF).

**J9131** 150 Assorted Metric Straight and Angled (M6/M8/M10).

**J9132** 80 Assorted Metric Straight and Angled (M6/M8/M10).

**J9133** 80 Assorted Imperial Straight and Angled (BSP/BSF/UNF).



### Grease Nipple Caps with Strap

**J9134R** Red. Packs of 100.



Not to be used with chemicals, petrol, other corrosive or volatile liquids unless specified. Do not test pumps with water. Keep pumps well oiled when not in use.

### Lever Drum Pump

High output lever action. Oil and Anti-freeze pump. 400cc per stroke (approx.). Extra strong. Telescopic tube. Anti-drip filter cap.

**J3016D2** For 205Ltr drum.

**Optional extra:** Above pump supplied with 'S' (J2650/S) adaptor that clamps on to most male treads.

**A1025SE** 1.5m outlet hose with shut off valve and nozzle.



### Gear Oil 'Stirrup' Pump

With 1.7m outlet hose, anti-drip 13mm o/d 90° spout, drain down and nozzle storage facility. Designed to fit those awkward to access filler points with a minimum i/d of 14mm. 2" BSP male thread. Pumps on down stroke. Designed for use with trolley A1083/SLB.

**J9022** For 20/25Ltr containers. Suitable for gear and all lubricating oils.

**J9022/S** J9022 pump supplied with 'S' (J2650/S) adaptor (fits most male threads).

**J9022/TS** J9022 pump for trisure threaded drums.

**J9022/61** J9022 pump supplied with a DIN61 Adaptor (female to female adaptor)



### Piston Pump

Suitable for lubricants, cellulose thinners, industrial solvents, chemicals cleaners and detergents. Nylon suction tube, steel nylon coated rod, viton seals. Check suitability for product before using.

**J3010/25** For 20/25Ltr containers. 500mm suction tube.

**J3010/205** For 205Ltr containers. 1000mm suction tube with 2" BSP adaptor.

**Note:** 20/25Ltr supplied with either A or B adaptor. (Please specify or choose from the adaptors on page 18 supplied at extra cost).



### Robust Heavy Duty Oil Pump

With 1.5m flexihose, valve and nozzle. Suitable for SAE 90 and heavier oils. Ideally suited for pumping heavy gear oil in cold climatic conditions.

**A1064SE** For 20/25Ltr containers. Supplied with 2" BSPM Bush (P1734/G).\*

**A1066SE** For 60 to 205Ltr barrels. Supplied with standard 2" BSP adaptor.

\* Other adaptors available at extra cost. (See page 18).



### Hand Operated Jumbo Semi-Rotary Pump

Cast iron, double acting with bronze vanes. For use with water, diesel and lubrication oils.

**K0** 1/2" BSP Inlet/Outlet. Flow rate 12Ltr/min.

**K1** 3/4" BSP Inlet/Outlet. Flow rate 22Ltr/min.

**K2** 1" BSP Inlet/Outlet. Flow rate 28Ltr/min.

**Accessories:** Inlet tubes, hose tails, hose and adaptors.

**NB:** Not to be used with Chemicals, Petrol, other corrosive or volatile liquids unless specified. Do not test pumps with water. Keep pumps well oiled when not in use.



## 1" Rotary Pump

250cc per revolution (approx.). With 3 piece steel inlet tube with non-return valve, 2" BSP adaptor and chrome plated outlet pipe.

**P0201** For 205Ltr barrels.

**P0201/48SE** As above but for 4' tanks. 1 piece tube.

**Optional extra:**

**P0204SE** Steel suction tube for 4' tanks, fitted with non-return valve.

**A1030SE** 1.5m outlet hose with nozzle.

**P0201/1** Extension tube and fitting.



## Metered Rotary Pump Kit

Mechanical meter, 3m hose, nozzle and 1" rotary pump. Suitable for Oil and Diesel.

**P0201SE** For 205Ltr barrels. (Illustrated).

**P0201TSE** As above but for 4' tanks.



## 4:1 Quick Flow Rotary Barrel Pump

**J3047** Supplied with 1.5m dispensing hose. Max. delivery 100Ltr/min.



## Side Lever Oil Gun

**A1018** 500cc. For oil over SAE 30.



### 20/25Ltr Mobile Gear Oil Unit

Fully adjustable to fit all known 20/25Ltr containers (round, square and rectangular). Pump is held firmly by the trolley unit. For gear oil, automatic transmission fluids and all other lubricating oils. Easy changeover of containers. Pump bracket secures drum.

- A1083/J9022** Mobile Gear Oil Unit
- A1083/J3016SE** With J3016SE lever pump, 1.5m hose and anti-drip nozzle.
- A1083/P0202SE** With P0202 rotary pump, 1.5m hose and anti-drip nozzle.
- A1083/A1064SE** With A1064SE heavy duty oil pump, 1.5m hose and anti-drip nozzle.
- A1083/J9022TS** For trisure threaded drums.



### Steel Gear Oil Bucket

With fully reversible hand rotary pump, clear PVC hose and nozzle. Hard powder coat finish as standard.

- A6000SE** 10.5Ltr (approx.) Robust steel base. Delivers and retrieves.

**Optional extra:**

- A6003SE** Outlet shut off valve kit.



### Steel Gear Oil Bucket with Lever Pump

Heavy duty pump. With hose, shut off valve and nozzle. Hard powder coat finish as standard.

- A6002SE** 10.5Ltr (approx.) Robust steel base. Delivers only.



### High Pressure Volume Bucket

For dispensing oil and grease via giant button head grease fitting. Steel gear oil bucket.

- A6004SE** With high pressure pump, hose and giant button head connector.

**Accessories:** Other connectors available see greasing section.



### 24Ltr Air Discharge Oil Dispenser

24Ltr tank, level indicator and oil dispensing gun.

- M3327** Maximum pressure 7 bar.



### 60mm Tournex & 34mm Snap-Top Adaptor

**J2650/A** For snap-top steel and some plastic 20/25Ltr containers. (Threaded for Plysu).



### 2" BSP Adaptor

**J2650/B** For Plastic 205Ltr barrels and 60Ltr drums.

**J2650/2** For Steel 205Ltr barrels and 60Ltr drums.



### Strong 2" BSP Polyfibre Adaptor

**J2650/P** For 25mm to 34mm tube dia. □

**J2650/N** For 19mm 28mm tube dia.

**J2650/M** For 32mm 42mm tube dia.



### 2" BSP Converter

**J2650/S** 2" BSP female - locks onto any male thread with a thumbscrew.



### Universal Plastic Adaptor

**J2650/U** Plastic.



### Plastic Ring Converter

**J2654/ADM**

**Threads:** 70 x 6mm male to 2" BSP female. **Colour:** Blue. **Application:** Plastic drums with MAUSER Buttress plugs 70 x 6mm. **Common Drum Types:** Mauser, Rexam Harcostar, Wiva, Gallay, Dynoplast, Roug, Ostensjo.

**J2654/TS**

**Threads:** 56 x 4mm male to 2" BSP female. **Colour:** Orange. **Application:** Plastic drums with TRISURE-EURO Buttress plugs 56 x 4mm. Most plastic drums 20, 25, 50 & 60Ltr. **Common Drum Types:** Van Leer, Economic Drums, Gem Plastics, Rexam Harcostar, Dynoplast, Roug, Hannells, Soltralentz, Schutz.



**J2654/DIN61**

**Threads:** DIN 61 female to 2" BSP female. **Colour:** Yellow. **Application:** DIN 61 external screw necks on 'L' ring drums or IBC's, Plysu 20-25Ltr drums with 59mm necks, Valerex 60mm necks, Dynoplast 25Ltr drums with DIN 61 neck. **Common Drum Types:** Van Leer (Valerex), Economic Drums, Galley, Mauser, Soltralentz IBCs, Schutz Drums and IBCs, Van Leer Unicubes.



**J2654/DIN71**

**Threads:** DIN 71 female to 2" BSP female. **Colour:** Brown. **Application:** 'L' ring drums from Germany with large aperture necks. **Common Drum Types:** Mauser, new Castrol & "Monty".

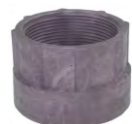

### 50mm to 2" BSP f/f Adaptor

**J2654/50** Fits Fuch's 20 Ltr brief case drum - Use with Oil Pump J9022



### Aluminium Ring Converter

**J9024/13** 59mm female to 2" BSP female tread.

**J9024/15** 2" BSP female to 2" Buttress female thread.



### IBC Cap/Adaptor

**J3040/CAP** 2" BSP bung.

### Airomatic Pumps

We recommend that all air operated pumps are used with an Air Management System (M5511 or similar) for extended operating life. It is strongly recommended that a pressure relief valve is fitted to fixed lube lines. They are designed to overcome the pressure build up due to heat expansion. Air operated pumps should not be left connected to an air supply and left unattended for long periods. Considerable damage or loss could occur if system failure occurs down stream of pump. Always provide adequate safety systems or disconnect from air supply.

All flow rate values are free flow estimates, flow rate can change depending on viscosity, temperature of the liquid and outlet system. These well proven, state of the art pumps are designed for long trouble free life. Operating pressures 3-8 bar min/max. Maximum air consumption 125Ltr/min @ 8 bar.

### Double Acting Oil Pumps - Technical Data

Product Code	Ratio	Air Inlet (BSP)	Oil Outlet (BSP)	Hose Dia. Ltr/min	Free flow Rate Ltr/min	Flow @ 10m Ltr/min	Flow @ 20m Ltr/min	Flow @ 40m Ltr/min
--------------	-------	-----------------	------------------	-------------------	------------------------	--------------------	--------------------	--------------------

Barrel Pumps (figures are @ max 8 bar, Gear Oil SAE20 @ 20°C).

M2040L2	1:1	1/4	3/4	3/4	40	30	-	-
M2020L2	3:1	1/4	1/2	1/2	28	20	10	-

Stub Pumps for tanks, IBC's and wall mounting.

M2038L3	3:1	1/4	1/2	1/2	28	20	10	-
M2059L2	5:1	1/4	1/2	1/2	12	8	7	4
M2091	9:1	1/4	1/2	1/2	5	@ 80m 3 Ltr/min		

Gear Oil Pumps (figures are @ max 8 bar, Gear Oil SAE140 @ 20°)

M2015	5:1	1/4	3/4	3/4	15	12	8	3
-------	-----	-----	-----	-----	----	----	---	---

Antifreeze and Waste-Oil Pumps

M2047	1:1	1/4	3/4	3/4	25	20	-	-
M2033	3:1	1/4	1/2	1/2	14	12	10	(ANTIFREEZE ONLY)

4' Tank and IBC Pumps - steel suction tube.

M2020/130	3:1	1/4	1/2	1/2	28	20	10	-
-----------	-----	-----	-----	-----	----	----	----	---



#### Single Air Distributor

Barrel pumps for engine oil and oils to SAE70.

**M2040L2** 1:1 For bulk transfer.

**M2020L2** 3:1 For short pipe runs and direct to hose reels.

#### Stub Pump Kits

For tanks, IBC's and wall mounting. Pump with 1.5m suction hose, non-return valve and filter.

**M2038L3** 3:1 For short pipe runs and direct to hose reels. (M2038 Pump only).

**M2059L2** 5:1 For heavier oils and long pipe runs. (M2059 Pump only).

**M2091SE** 9:1 For heavy gear oil and longer pipe runs. (M2091 Pump only).

**M2047SE** 1:1 For antifreeze and waste oil. (M2047 Pump only).

**Note:** See technical data for specification and flow rates.





### Air Management System

This compact system combines pressure regulator with filter, lubricator and gauge. It optimises the efficiency and the life of the pumps when in regular use, also preventing the seizure of moving parts. (Ideally should be installed next to pump.)

**M5511** 1/4" BSP.

**M5511/1** Gauge - Air Management System



### Oil Pump Kit

Oil pump with suction hose, (M5511) air management system, (M8651) 1m connection hose for outlet, (P4204) 1/2" BSP ball valve, (M7550) 8m coiled air hose.

**M2038KIT** 3:1 M2038SE. For barrel, tank, wall mounting.

**M2059KIT** 5:1 M2059SE. For barrel, tank, wall mounting.



### Wall Mounting Kit Bracket

For use with stub pumps:- M2043, M2038, M2059, M2091.

**M8265** Bracket only with 2" BSP ring.



### Air Line Coupling 1/4" BSP

**J5511/7** Male thread.

**J5511/8** Female thread.



### Air Line Adaptor 1/4" BSP

**J5511/9** Male thread.

**J5511/10** Female thread.



### Air Line Hose

**M7550** 8m coiled. 1/4" BSP. Available colours blue, red or yellow.



### Oil Dispensing Nozzle - Rigid Spout

**M2118L** With non drip valve and standard swivel joint. ½" BSP (F) inlet.

### Oil Dispensing Nozzle - Flexible Spout

**M2131L** As M2118 with 90° angle tube and flexible hose.



### ½" BSP Flexible Hose

For use with oil dispensing nozzles.

**M2190** 90° with non drip nozzle.



### Oil Dispensing Kit

Comprising:- M2118 nozzle, reinforced hose and ½" BSP heavy duty swivel joint for making manoeuvrability much easier.

**A5502SE** 3m kit.

**A5503SE** 6m kit.



### High Delivery Oil Gun

**M2119** 1" BSP, 150Ltr/min, max pressure 10 bar.

### High Delivery Dispensing Kit for 1:1 Pumps

**A5508SE** Nozzle with 3m x 25mm bore hose. Max pressure 10 bar.

### Digital Oil Dispensing Kit

Comprising:- M2926 nozzle, reinforced hose and ½" BSP heavy duty swivel joint for making manoeuvrability much easier.

**A5504RSE** 3m kit. (Illustrated).

**A5504R** 3m reinforced hose assembly only.

**A5505RSE** 6m kit.

**A5505R** 6m reinforced hose assembly only.



### Digital End Meter

Min 1Ltr/min, Max 20Ltr/min, Max. Pressure 50 bar, +/- 0.5% accuracy. Not for resale use.

**M2826L** With spout, 12mm non drip nozzle, ½" BSP (F) swivel inlet.

**M2933L** As M2826 with 90° angle tube and flexihose. (Illustrated).



### Digital Pre-Set End Meter

With pre-settable meter to 99.999Ltr or 99.999 gallon. Max 20Ltr/min, Max. Pressure 50 bar, +/- 0.5% accuracy. Not for resale use.

**M2941L2** With spout, 12mm non drip nozzle, ½" BSP (M) swivel inlet.



### Swivel Joint ½" BSP M/F

**M2106** From pump body to outlet hose and dispensing nozzle.



### ½" BSP High Pressure Digital Oil Meter

**M2929L** In line oil meter. Max pressure 50 bar, 20 Ltr/min.

**M2826L/BAT** Replacement Battery.





### Mobile Oil Dispensing Kit

Comprising:- 1:1 ratio pump, 3m hose, M2826 digital nozzle, M7550 air hose, M5511 air management system and M4388 trolley.

**M4389KIT** For 205Ltr barrels. (Supplied without barrel).



### Mobile Oil Dispensing Hose Reel Kit

Comprising:- 3:1 ratio pump, M2826 digital nozzle, M5511 air management system, M9016 hose reel and connecting hose M7550 air hose and M4389 trolley.

**M4389KIT/H** For 205Ltr barrels.

**Note:** Similar kits can also be supplied for grease.



### Wall Mounted IBC Dispensing Pump Kit

Comprising:- 1:1 ratio pump, M2047. Complete with QR 2m hose, 2" BSP male fitting assembly, M5511 air management system, air hose, wall bracket. For Diesel or Oil.

**M2047KIT** Allows for quick changeover of IBC's.

**Note:** Delivery hoses, see previous page.



### IBC Dispensing Kit

Pneumatic Dispensing Systems can be supplied for dispensing of diesel, oil, chemicals and other industrial products. We can also provide Electric Pumping Systems from 12v to 3 phase. Manual Pumps, with modifications can also be supplied to fit an IBC. Pumps can be mounted on the bracket with or without a drip tray.

Comprising:- Bracket for 1000Ltr IBC with drip tray, 15m retractable hose reel, 3:1 air operated pump, modified cap for IBC, digital dispensing gun M2826, connecting hose (pump to reel) and M5511 air management system.

**Please contact us with your particular requirements.**

**M8210KIT** For 1000Ltr IBC.



### Petrol Engine Pump Kit

Powerful petrol driven 4hp motor. Special 2" BSP pump. Mounted in tubular carrying guard frame. Fuel capacity 2.5Ltr. Running time at full load 2 hours approx. For hydraulic, engine and gear oil. (Will empty a barrel of engine oil in approx. 4 mins).

**J0005SE** With 5m outlet hose and J3072 nozzle, 2m inlet hose, 38mm bore.

**J0005SE/QR** As above with quick release hoses and caps.

**J0009/5SE** 5m extension hose with quick release and caps.

Product Code	Voltage (v)	Power (kw)	Operating Pressure (bar)	Connection (BSP)	SAE	Flow Rate (SAE30) Ltr/min	Size (mm)	Weight (kg)	Suction Lift (m)
<b>ALL HAVE IP55 PROTECTION</b>									
J3074	110	0.5	3	3/4	90	25	330x150x210	15	1
J3075	240	1	3	3/4	90	20	320x270x160	9	2.5
J3077	12	1	8	½	90	30	295x165x100	10	2.5
J3075MSE	240	1	3	½	90	15	370x265x380	18	2.5
J3077MSE	12	1	8	½	90	15	370x265x380	19	2.5
J3085	240	0.5	3	3/4	90	20	330x150x210	15	1
M6135/50	240	2	20	1 in 3/4 out	90	50	420x180x280	18	1
M6312	12	0.4	3	3/8	15	10	200x150x150	8	1

Note: Valid flow rates at pump outlet.



### Geared Oil Pump Kits

With self ventilated motor, continuous function, re-circulation by-pass. Comprising:- Pump, 3m outlet hose, nozzle, inlet hose. For oils and light gear oils.

- J3077** 12v Pump only.
- J3077KIT** 12v Pump kit with M2118 nozzle.
- J3077MSE** 12v Pump kit with M2826 digital meter nozzle.
- J3074** 110v Pump only. Vane Pump.
- J3075** 240v Geared Pump only.
- J3075/V** 240v Vane Pump, 25 L/min
- J3075KIT** 240v Pump kit with M2118 nozzle. (Illustrated).
- J3075MSE** 240v Pump kit with M2826 digital meter nozzle.



### 240v Eccentric Oil Pump

Also for waste oil.

- J3085** Pump only.



### 12v Pump for Light Fluids

For water, antifreeze, diesel, light oil and other fluids. (Not for use with petrol/volatile liquids). 24v also available.

- M6312** Brass chamber with viton seals. Max running time 30mins.



### High Output 240v Oil Pumps

- M6135/50** As M6135 but operates at 2500 rpm.



## AdBlue

On 1st October 2006 the Euro IV was introduced for new vehicles. This was an update from the EU guideline on the control of toxic fumes from heavy-duty diesel powered vehicles.

We have developed a new range of pumps and dispensing units to supply UREA/AdBlue solution AUS 32. (Urea solution DIN 70070 - NOx reducing agent). The Materials used are compatible with the solution. Our kits have differing features to satisfy varying requirements. These are detailed below.

## 240v AdBlue Pump Kit

Comprising:- Wall/IBC mounting base with nozzle holster, 1.5m inlet hose and telescopic tube for Barrel or IBC, 4m delivery hose with Auto Shut-off Nozzle.

**J3040/ADB** Barrel kit.

**J3040/ADBIC** IBC Kit.

### Specification:

- Centrifugal self-priming pump
- Flow rate of kit 35L/min
- Motor: 0.37kw, 230v, 50hz, single phase, self ventilated S1 continuous duty, 2800rpm, IP-44 Protection
- On/Off switch, 2m electric cable
- Inlet/outlet 1"bsp. Maximum suction length 8m.
- Maximum pressure 3.2bar
- Min/max temperature -5 ~ +60C

### Optional Extras and Replacement Items:

**J3040/SS** Stainless steel auto shut-off nozzle, 3/4" BSP, 19mm spout.

**J3040/SSKIT** S/S Auto Nozzle c/w S/S Swivel

**J3040/NOZZ** Plastic nozzle, 3/4" BSP, 19mm spout.

**J3040/CAP** IBC cap with 2" BSP insert.

**J3040/CON** CDS connector for modified IBC.

**J3040/90** Elbow connector

**J3040/2P** Rigid Suction Tube

**J3040/HOSE** 1m Black AdBlue Hose

**J3040/DM** AdBlue in-line Digital Meter, 1" BSP.

## AdBlue Hose Kit

**J3040/GK** 4m hose, J3040 nozzle and J2654/DIN61 Adaptor for IBC.

**J3040/GK3M** 3m hose, J3040 nozzle and J2654/DIN61 Adaptor for IBC.

**J3040/SSKIT** 3m hose kit with J3040/SS auto nozzle for pumped systems.

## Self Assembly Gravity Kit

**J3040SA** 4m Clear hose Plastic Nozzle Kit.

**J3040SA/3M** 3m Clear hose Plastic Nozzle Kit.





## Manual AdBlue Barrel Pump

Suitable for a 205 Ltr barrel  
Delivery Hose Included

**J3040/ADBB** Manual AdBlue Barrel Pump

**J3040/ADBBSE** Manuel AdBlue Barrel Pump c/w Adaptor



## Mega Pump

**J1403MP** 12v-240v Pump suitable for most drums, tanks and IBC's



## Plastic Rotary Pump

Polypropylene body and tubes vanes and rotor with Vitton seals, 2" BSP Adaptor, 3 piece suction tube, 3/4" BSP inlet/outlet threads.

**J1626** For AdBlue, water based solutions, petroleum products. 2" BSP Adapter

**J1626/TS** As above, but c/w J2654/TS adaptor for most plastic barrels



## Teflon Lever Barrel Pump

**J3018/TS** 2" BSP c/w J2654/TS adaptor for most plastic barrels.



## 240v Self-Priming AdBlue Pump

### Specification:

Flow: 35 Ltr/min. Bypass incorporated. Max Suction length 4m. Suction height 2.5m.  
Motor: 230v, 50hz, single phase. IP-55 Protection. Maximum dry running = 3 minutes On/Off luminous switch.

### Pump Kits for Barrels

Comprising: Pump, 4m outlet hose, 1m inlet hose, foot valve, strainer and nozzle

**J3040/PUMP** 240v AdBlue Pump only

**J3040/KIT** 240v AdBlue Pump kit c/w manual nozzle

**J3040/KIT/A** 240v AdBlue Pump kit c/w stainless steel auto shut-off nozzle



## 12v Self-Priming AdBlue Pump

### Specification:

Flow: 32 Ltr/min. Motor 12vDC. IP-55 Protection. Continuous duty. Maximum dry running = 3 minutes. Carrying handle. On/Off luminous switch. 1.8 metre battery cable and clips.

### Pump Kits for Barrels

Comprising - Pump, 4m outlet hose, 1m inlet hose, foot valve, strainer and nozzle.

**J3040/PUMP12V** 12v AdBlue Pump only

**J3040/12KIT** 12v Pump kit c/w manual nozzle

**J3040/12/KITA** 12v Pump kit c/w stainless steel auto shut-off nozzle





## Mega Pump

**J1403MP** 12v - 240v Pump suitable for most drums, tanks and IBC's

**Power Source:** DC 12V - 20V  
**Delivery Volume:** Approx. 19LPM (5GMP)  
**Discharge hose length:** Approx. 2m (6.6ft)

**Applicable liquids:**  
Diesel, DEF (AdBlue), Water, Kerosene, Antifreeze, Windshield washer fluid, Mild detergents, Agricultural chemicals, Light oils



## Quick Flow Fuel Pumps

Geared pumps for increased output. .

### 4:1 Quick Flow Rotary Barrel Pump

**J3047** Supplied with 1.5m dispensing hose. Max. delivery 100Ltr/min.



## Quick Flow Fuel Pump Kit

**A1070SE/M** J3047 Pump kit.

**A1070SE** Without meter.

J3047 Pump complete with A1003SE fuel filter, M0085 flow meter, 3mtr diesel hose and J3063 nozzle.



### Hand Operated Jumbo Semi Rotary Pump

Cast iron, double acting with bronze vanes. For use with water ,diesel and lubricating oils

**K0** ½" BSP inlet/outlet. Flow rate 12 Ltr/min.

**K1** ¾" BSP inlet/outlet. Flow rate 22 Ltr/min.

**K2** 1" BSP inlet/outlet. Flow rate 28 Ltr/min.

**Optional Extras:** Inlet tubes, hose tails, hose and adaptors



### 1" Rotary Pump

250cc per revolution (approx). With 3 piece steel inlet tube with non return valve, 2" BSP adaptor, chrome plated outlet pipe.

**P0201** For 205 Ltr barrels

**P0201/48SE** For 4' tanks and IBC's with one piece inlet tube

**Optional Extras:**

**P0204SE** Steel suction tube or 4' tanks, fitted with non-return valve

**P0205** Locking bracket

**P1030SE** 1.5m Outlet Hose with Nozzle

**P0201/1** Extension tube and fitting



### Metered Rotary Pump Kit

**P02012SE** For 20 Ltr barrels

**P02012TSE** As above but for 4' tanks and IBC's





## Air Operated Diesel Pump

Ratio 1:1. Delivery 25Ltr/min - sustainable over long distances. Operating pressure 3 - 8 bar. Outlet 3/4" BSP. Comprising:- wall bracket, 1.5m suction hose which is open ended.

**M2047SE** For use with tanks, barrels etc.

### Optional Extras:

Outlet hose and fittings, inlet fittings with non-return valves, filter, tube etc and air management system.



## Manual Shut Off Dispensing Kit

J3063 Manual nozzle with 3m x 25mm bore hose, 3/4" BSP fittings.

**A5506SE** Max pressure 10 bar.

## Auto Shut Off Dispensing Kit

J3070 Auto shut off nozzle with 3m x 25mm bore hose, 3/4" BSP fittings.

**A5507SE** Max pressure 3 bar.



## Roller Vane Air Motor Kit

30Ltr/min (up to 5m) compressed air roller vane motor suitable for diesel. 1 bar outlet pressure. On/off air supply valve. 3/4" BSP ports, supplied with hose tails for 25mm bore hose and 2" boss for fitting to wall bracket.

**M6557** Roller vane air motor.

### Optional Extras:

**M8265** Wall mounting bracket.



## Roller Vane Pump Barrel Kit

Pump specification as M6557. Supplied with manual dispensing nozzle, 3m hose, inlet tube with 2" BSP adaptor and air line hose.

**M6556SE** To suit barrels.

**Note:** Filters are recommended to be installed before pump. Filters and lubricator are recommended for air supply.



## Petrol Engine Pump Kit

Powerful petrol driven 4hp motor. Special 2" BSP pump. Mounted in tubular carrying guard frame. Fuel capacity 2.5Ltr. Running time at full load 2 hours approx. For diesel, hydraulic, engine and gear oil. (Will empty a barrel of diesel in approx. 2 mins). Supplied complete with 5m outlet hose and J3072 nozzle. 2m inlet hose, bore size 38mm. Max static pressure 7 bar.

**J0005SE** Fuel tank capacity 2.5Ltr.

**J0005SE/QR** As above with quick release hoses and caps. (Illustrated).

### Optional Extras:

**J0009/5SE** 5m extension hose with quick release and caps.

**J0500/IBC** Adaptor converts IBC valve to 1 1/2" camlock attachment for use with J0005SE.

### 12 & 24 Volt Submersible Pumps

Suitable for diesel, various chemicals, fresh and dirty water. Ideally suitable for on-site diesel refuelling of contractors and agricultural plant. Efficient and easy to clean filters. Pumps can be run continuously for periods of up to 1 hour. Pumps must not be allowed to run dry. Not to be used with petrol or liquids with flash point range -20° to +80°C. Keep submerged when used with water, even when not in use.

Product Code	Voltage V	Free Flow Ltr/min	Pressure psi	Head metres	Current Maximum amps	Length cm	Diameter cm	Weight kg	Body	Cable Length w/ battery clips (m)	Hose dia	Outlet hose (m)	Seals/O rings
J0024	24	18	15	11	3.5	14.5	5.4	0.6	PP	4	½"	3	NBR/NBR
J3013SS	12	20	14	10	6	16.2	3.7	0.6	Acetpy	4	½"	3	Rubber/Graphite



J3013SE

**J0023** 12v pump kit. 53mm diameter.

**J3013SS** 20 L/min Stainless 12v pump. 38mm diameter.

**J3013SS/KIT** 20 L/min Stainless 12v pump kit. 38mm diameter.

**J3014** High output 30 L/min 38mm dia Pump only, 19mm o/d outlet

**J0024** 24v pump kit. 53mm diameter.

**J3012 & J3024** 12v/24v 25 L/Min High output 38mm diameter. Pump only.

### 12v & 24v Electric Pumps

Only suitable for use with diesel. Pumps are self-priming with re-circulation by-pass.

Product Code	Voltage	Watts	Amps	RPM	Flow Rate of pump Ltr/min	Max Run time per hr (min)	Max Head (m)	Max Suction (m)	Protection (P)	Weight (kg)	Ports (BSP)
J3058	12	270	18	2800	50	CONTINUOUS	12	2.5	54	3.7	3/4
J3057/24	24	500	21	2000	85	30	-	-	55	9.9	1 ½"
J3073	24	270	10	2800	50	CONTINUOUS	12	2.5	54	3.7	3/4
J3057	12	400	35	2800	70	30	20	3.5	54	6.8	1"
J1224	12/24	192/520	16/22	1400/2200	45	30/10	12	2.5	54	7	3/4

**Note:** Valid flow rates with manual nozzles. Flow rates are reduced by approximately 2Lpm when using a meter. Flow rates are reduced by 14% through automatic nozzles. **Important:** Filters must be installed before pump and meter.



12v & 24v Dispensing Kits comprise: Pump, 3m outlet hose, 1m inlet hose, manual nozzle, swivel, fittings and hose end filters for 12/24v.

**J3058** 12v pump only.

**J3058/KIT** 12v pump kit. (Illustrated).

**J3058KIT/M** 12v pump kit c/w meter.

**J3057** 12v pump only. 70 L/Min Bi Pump

**J3057/24** 24v 70 L/min Bi Pump.

**J3082** Mountable 24v Bypass Pump

**J3073** 24v pump only.

**J3073/KIT** 24v pump kit.

**J3073KIT/M** 24v pump kit c/w meter.

**J1224** 12/24v dual voltage pump only.

**J1224/KITC** 12/24v dual voltage pump kit. (Illustrated).

### 110v & 240v Electric Pumps

All diesel pumps are suitable for pumping class 'C' fuels (not petrol or liquids within flash point range -20° to +80°C). Self-priming pumps with re-circulation by-pass. Built in pre-filter.

Product Code	Voltage	Watts	Amps	RPM	Flow Rate of pump Ltr/min	Max Run time per hr (min) (Not dry)	Max Head (m)	Max Suction (m)	Protection (P)	Weight (kg)	Ports (BSP)
J3076L2	230	550	2.8	2800	60	Continuous	20	3.5	55	7	1
J3076/110	110	550	2.8	2800	60	Continuous	20	3.5	55	7	1
J3056L2	230	550	4	1400	80	Continuous	20	4	55	13	1
J3036	230	550	4.5	1400	100	Continuous	25	4	55	14	1

**Note:** Valid flow rates with manual nozzles. Flow rates are reduced by approximately 2Lpm when using a meter. Flow rates are reduced by 14% through automatic nozzles. **Important:** Filters must be installed before pump and meter.

### Dispensing Kits

Comprising:- Pump, 3m outlet hose, 1m inlet hose, manual nozzle, swivel, fittings (built in pre-filters).

#### 110v

**J3076/110** 110v Pump only. 60Ltr/min.

**J3076/110/KIT** 110v Pump kit with Manual Nozzle.

**J3076/110KITA** 110v Pump kit with J3070 auto shut-off nozzle.



J3076/110

#### 240v

**J3076L2** 240v Pump only. 60ltr/min

**J3076KIT/MBAL2** 240v Pump kit with auto shut-off nozzle, meter & mounting base. 60 L/min

**J3056L2** 240v Pump only. 80Ltr/min.

**J3056KIT/A** 240v Pump kit with J3070 auto shut-off nozzle. 80 L/min

**J3056L2/MBA** 240v Pump kit with auto shut-off nozzle, meter & mounting base. 80Ltr/min.

**J3036** 240v Pump only. 100Ltr/min.

**J3036KIT/A** 240v Pump kit with J3070 auto shut-off nozzle. 100Ltr/min



J3076KIT/MBAL2



## Gravity Feed Hose Kits 1" BSP

Heavy duty hose with 90° lockable gate valve, trigger nozzle with swivel.

**A1000SE** 3m.

**A9004SE** 4m.

**A9005SE** 5m.

**A9006SE** 6m.

**A1009SE** 3m with washable filter and locking plate. (Illustrated).



## Hose only with End Fittings

**A1001SE** 3m.

### Optional Extras:

**J3061** 1m x 25mm bore (order length required).\*

\*Can be supplied as additional lengths to A1001SE and other kits.



## Metered Gravity Feed Hose Kit

**A1203SE** 3m c/w M0085 meter.

## 1 1/2" BSP Gravity Feed Hose Kit

**A9103SE** 3m c/w J3072 high delivery nozzle.

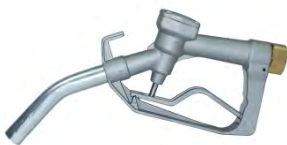

## Manual Nozzles

**J3063** Aluminium with 1" BSP swivel. Max flow rate 60Ltr/min.

**J3079** Polyprop with 25mm swivel hose connector.



## High Output Manual Nozzle

Maximum flow rate 200Ltr/min. Three lock-open trigger settings. Manufactured in aluminium. Maximum pressure 3 bar.

**J3072** 1 1/2" BSP female. (Illustrated with swivel - J3072SE).

### Accessories:

**J3072/S** 1 1/2" BSP swivel for above.

## Automatic Shut-Off Nozzle

Will not operate with gravity feed systems. Nozzle shuts off automatically when liquid covers the vent hole at the end of the spout. For use with diesel/gas oil. 1" BSP swivel inlet. Pumps should deliver a minimum of 13Ltr/min to activate 'shut-off' mechanism. Built in check valve, low-flow 'shut down', simple lever catch. Maximum pressure 3 bar.

**J3070** 60Ltr/min. 25mm O/D nozzle.

**J3070/2** 120Ltr/min. 30mm O/D nozzle.

**J3071** 70Ltr/min. For unleaded petrol.

**J3040/SS** 60Ltr/min. Stainless steel. For AdBlue.

### Accessories:

**J2533** 1" BSP M/F swivel joint.

**J2532** 3/4" BSP (M) to 1" BSP (F) swivel joint.





### 1" BSP Mechanical Meter for Fuels, Oils etc.

Suitable for gravity, manual or electric pumps with by-pass. Not to be used with air operated pumps. Electric pumps must have bypass. Easy calibration, not for resale use.

**M0085** Aluminium back.

#### Technical Data:

Flow Rate:	20-80Ltr/min
Calibration Accuracy:	+/- 1.0% flow volumes between 20 and 80Ltr/min
Working Pressure:	3.5 bar max (Pressure 13 bar max static)
Maximum Temperature:	65°C
Inlet/Outlet:	1" BSP
Inlet Feed and Outlet:	Vertical or horizontal.
Weight:	1.8kg
Dimensions:	140x170x200mm
Display:	4 figure plus 6 figure non-resettable totaliser in Litres



### Digital Inline Meter

Aluminium body, flow range 10-100Ltr/min, Display: Batch 999.9, Cumulative 9999. Powered by 2 x AAA batteries. Max operating pressure 20.7 bar. Not for resale use.

**M0087** 1" female ports.



### Digital Meter for Diesel & Lube

In line meter with large display.

**M0089** 1" BSP.

- Big Display
- Oval gear aluminium meter
- Flow rate 5-80 l/min
- Max pressure: 40 bar
- Temp: 10/+60c
- F1" Connection or flange
- Lithium Cell (approx 5 years)
- Vertical or horizontal fluid direction
- Total and partial of supplied litres
- Suitable for diesel and lubricant



### Fuel Filters

See through gravity filter units: 1" BSP inlet/outlet ports. Flow rate with 600mm head 22Ltr/min, max pressure - 10.7 bar (150 psi). (Flow is restricted when filters need changing).

**A1003/G** 1Ltr dirt particle filter unit complete. (Illustrated).

**A1003/WG** 1Ltr water block filter unit complete.

**J3049/G** Replacement dirt particle element (10 micron).

**J3049/WG** Replacement water block element (15 micron particle).



### Y Strainer

**P4506** 1" BSP 'Y' strainer, female inlet/outlet.



### 1" Breakaway Coupling

**J3069** Not re-usable.



### 240v Explosion-Proof Pump

- Output 80Ltr/min at pump
- Pressure 0.4 bar
- Ports 1" BSP and flange
- Re-circulation bypass
- Continuous run time
- Max head 20m
- Max suction 4m
- Protection IP55/thermal
- Eccentric with auto adjustable blades
- Built in pre-filter

**J3056/EXP** 240v Explosion proof pump



### Fuel Drainer Syphon Kit

Many uses including: Transferring fuel from car to car or motorcycle to motorcycle. Extracting fluid from tanks. Extracting water from fish tanks. Pumping fuel into heaters, priming diesel fuel lines etc.

**J2655** Fuel syphon kit



### Automatic Shut-Off Nozzle

20mm o/d nozzle. Suitable for petrol. Supplied with 3/4 BSP swivel. 80Ltr/min max output. Nozzle shuts off automatically when liquid covers the vent hole at the end of the spout. Pumps should deliver a minimum of 13Ltr/min to activate 'shut-off' mechanism. Built in check valve, low-flow 'shut down', simple lever catch. Maximum pressure 3 bar.

**J3071** 70Ltr/min (shown with wall mounting bracket J3080 not included).

### Manual and Syphon Pumps

Pumps in this section are not to be used with products not specified and not with products with a flash point between -20c and +80c unless specified. With telescopic suction tube, 2" BSP male thread, 300cc per stroke (approx).

#### Plastic Lever Barrel Pumps

**J3017** Blue Polypropylene Pump Body, Viton Seals, Steel rod

**Note:** Suitable for use with oils, diesel, antifreeze and kerosene.

**J3018** Black Pump body ryton, stainless rod (316SS), teflon seals. (Suitable for

**Note:** Suitable for use with acids, chemicals, water and water based liquids.

#### Plastic Rotary Pump

Polypropylene body and tubes, ryton vanes and rotor, viton seals, 2" BSP adaptor, 3 piece suction tube, 3/4" BSP inlet/outlet threads.

**J1626** For AdBlue, water based solutions, petroleum products.\*

**\*Note:** Check suitability with solution manufacturer.

**Optional extra:**

**J1626/TS** With J2654/TS adaptor for AdBlue plastic barrels. (Illustrated).

#### Piston Pumps

Suitable for cellulose thinners, industrial solvents, brake fluid, mild acid based chemicals, cleaners and detergents. Nylon suction tube and seals, steel nylon coated rod and viton seals.

**J3010/25** To suit 20/25 Ltr containers.

**J3010/205** To suit 205 Ltr barrels.

**Note:** 20/25Ltr supplied with either A or B adaptor. (Please specify or choose from the adaptors on page 18 supplied at extra cost).

**A1025SE** 1.5m outlet hose, on/off valve and nozzle.

#### Stainless Steel Lever Barrel Pump

Suitable for solvents and corrosive chemicals. 2" BSP male thread. Teflon (PTF) seals. Output 130cc per stroke.

**M5495** To suit 205 Ltr barrels.

#### Plastic Syphon Pumps

Suitable for petrol, paraffin, diesel, insecticides, distilled water, detergents etc.

**J2651** To suit 5/20 Ltr containers. Suction tube length 400mm.

**J2653** To suit 205 Ltr containers. Suction tube length 850mm.

#### Fuel Drainer Syphon Kit

Many uses including: Transferring fuel from car to car or motorcycle to motorcycle. Extracting fluid from tanks. Extracting water from fish tanks. Pumping fuel into heaters, priming diesel fuel lines etc.

**J2655** Fuel syphon kit.





## Air-Motor Pump for Wall Mounting

Suitable for solvents, water and aggressive liquids. 2" BSP fixing ring, aluminium body, stainless steel pump casing with PTFE seals and teflon vanes. Air supply: max 8 bar/min 2 bar. 10 Ltr/min, hose tails for 12mm bore hose, on/off air supply valve, air roller vane motor. Output regulated by adjusting air supply

**M1058** 3/4" BSP ports. 1/4" BSP air inlet.

### Optional extras:

**M8265** Zinc plated wall mounting bracket.

**M1103** Stainless steel (316SS) wall mounting bracket.

## Stainless Steel Air-Operated Stub Pumps

Product Code	Ratio	Min/max Operating Pressure (bar)	Delivery Capacity (Ltr/min)	Max Suction Lift (m)	Shank Length (cm)	External Shank Dia. (Mm)	Outlet Ports (BSP)	Air Inlet
M1045	1:1	2-8	40	2	95	55	3/4	1/4"
M1019	3:1	2-8	14	2	95	40	1/2	1/4"
M1022	5:1	2-8	14	2	95	40	1/2	1/4"

Pumps have viton seals.

**M1045** 1:1 ratio.

**M1019** 3:1 ratio.

**M1022** 5:1 ratio.

### Accessories:

**M1104/09** Rigid shaft for 205 Ltr barrel.

**M1104/10** Rigid shaft for IBC.

**M1105** Flexible hose for tanks with stainless steel foot valve and filter. (Illustrated).



## Stainless Steel Barrel Pump

**M1040** 1:1 ratio pump for 205 Ltr barrel.

## Air-Operated 1:1 Diaphragm Pumps

These pumps have a wide range of chemical resistance and are ideally suited for workshops and industrial use. The pumps can easily pass small suspended solids found in waste oil etc. They can also be used with water, antifreeze, detergents and many other fluids.

Product Code	Ratio	Flow Rate (Ltr/min)	Inlet/Outlet BSP (F)	Air Inlet BSP (F)	Suction Lift (m)	Max Particle Size	Weight (kg)	Max Air Supply Pressure
P0210	1:1	56	1/2"	1/4	8	1.6	4.54	6.9
P0211	1:1	132	1"	1/4	8	3.17	14.1	8



**P0210** 1/2" BSP. Aluminium body.

**P0211** 1" BSP. Aluminium body (Illustrated).





### 12v Pump for Light Fuels

For use with water, antifreeze, diesel, light oil and other fluids. (Not for use with petrol/volatile liquids). 15 Ltr/min. Brass chamber with viton seals. Maximum running time 30 minutes. Brass tails for 14mm ID hose.

**M6312** 12v with 3/8" BSP ports.

**M6324** 24v with 3/8" BSP ports.



### 240v Pumps

For use with water and antifreeze.

**J3085** 240v with 3/4" BSP ports for antifreeze. 35 Ltr/min.

**M6440** 240v with 1" BSP ports for water. 40 Ltr/min.



### Mega Pump

**J1403MP** 12v - 240v Pump suitable for most drums, tanks and IBC's

**Power Source:** DC 12V - 20V

**Delivery Volume:** Approx. 19LPM (5GMP)

**Discharge hose length:** Approx. 2m (6.6ft)

**Applicable liquids:**

Diesel, DEF (AdBlue), Water, Kerosene, Antifreeze, Windshield washer fluid, Mild detergents, Agricultural chemicals, Light oils



### Electric Drill Pump Attachment

Attaches to drills with maximum 2000 rpm. Max flow rate 50 Ltr/min. Suitable for diesel, water and light oils. Made from especially strong polymers. Hose tails for 22mm ID hose.

**J3055** Adapts to all drills.



### 12v Diesel Pump

**J3013SS** 12v High Output Stainless Steel Diesel Pump

See full range on Page 30



### Water Pressure Soluble Coolant Mixer

Chemical proportioner with air gap eductor. Water board approved (WRAS). System includes proportioner unit, supply tubing, foot valve assembly. Discharge tubes (1 inner and 1 outer tube) and metering ratio tip kit, hook for discharge tube, full instruction sheet - easy to install. Flow rate min 4 Ltr/min, max 14 Ltr/min, minimum water supply hose 13mm ID, minimum line pressure with water running 25 psi/1.76 bar. The metering ratio tips are selected to give the correct solution concentration.

**J1116**      Mixing ratio 3:1 to 350:1.



### 24 Ltr Air Discharge Mobile Sprayers

With level indicator, pour-off funnel, spray lance and 5m spiral hose. Suitable for use with low-density lube oils, detergents and disinfectants.

**M3325**      24 Ltr with painted steel tank.

**M3324**      24 Ltr Stainless steel tank and nozzle.



### Air-Line Spray Gun

Suitable for releasing and light lubricating oil (non corrosive liquids).

**M7315**      1 Ltr capacity.



### Open Hose Reels - Grease

1/4" BSP inlet/outlet. 600 bar max pressure. Adjustable dispensing arm. Painted steel.

**M9018** 15m x 1/4" bore.

### Open Hose Reels - Oil

1/2" o/d 1/2" inlet. 200 bar max pressure. Adjustable dispensing arm. Painted steel.

**M9016/R** 15m x 1/2" bore with 1.5M Connecting Hose.

**M9021** 20m x 1/2" bore.



### Open Hose Reels - Diesel

**M9034/15** As above with 15m 1" i/d hose.

**M9034/20** As above with 20m 3/4" i/d hose.



### Oil Hose Reel Kit

Comprising:- 15m hose reel, connecting hose, ball valve, 'Y' strainer and digital dispensing nozzle.

**M9016KIT** 15m. x 1/2" Bore



### Air and Water Hose Reel

With 1.5M Connecting Hose. 1/2" Female BSP

**L8630** For air and water, 1/2" BSP (f) swivel inlet 1/4" BSP outlet, 20 bar, 3/8" i/d hose.



### Stainless Steel Hose Reel

**L8204** For oil and water. 1/2" BSP swivel. 20 bar. 1/2" i/d hose.



### Connecting Hose

For connecting reel to pump or pipework.

**M8651** 1.5m connecting hose for oil, air and water. 1/2" BSP.

**M8652** 1.5m connecting hose for grease. 1/4" BSP.

**A5511R** 1.5m connecting hose. 3/4" BSP.

**A5512R** 2m connecting hose. 1" BSP.



### Drip Tray and Holding Bracket

Digital nozzle not included.

**M9784** For wall mounting.



### Air Blow Gun c/w 8m Spiral Hose

**M7302SE** 1/4" BSP female.

**M7302** 1/4" BSP female, gun without hose.

## Double-Barrel Plastic Sump Pallets

Plastic sump pallets ensure the safe storage and containment of spillage of liquids, and meet with EC regulations. They can be used individually or in multiples and in conjunction with barrel racking, to enable horizontal or vertical storage. Manufactured from 4mm steel plate, removable steel decking, forklift facility, powder coated for durable finish. All units have integral sumps with capacities well in excess of current environmental and COSHH regulations. Use of this equipment could result in some or all of the following benefits:



1. Satisfy fire department regulations, insurance regulations, environmental audits, COSHH and Environmental Protection Act "Duty of Care".
2. Savings on expensive absorbents and operational cleaning costs.
3. Encourage good housekeeping and a more professional workplace.

Products are designed to comply with the following acts:

- Environmental Protection Act 1990
- BS7750
- Health & Safety at Work Act 1990.
- COSHH Regulations 1986.
- Control of Pesticides Regulations 1986.
- HFL/HPG Regulations 1972.
- Petrol Consolidation Acts 1928 and 1930.
- COP 1974.
- HS(G)51

For 205Ltr barrels

**M8523** 2 x 205Ltr barrels.

**Optional Extras for IBC's:**

**J2654/DIN61** Adaptor to convert Drain valve to 2" BSP. Allows the fitting of J4176/G Drum Tap

**J3040/CAP** Cap with 2" BSP.

**J0500IBC** DIN61 - 1.1/2" IBC/Camlock.

## Single Skin Steel Tanks

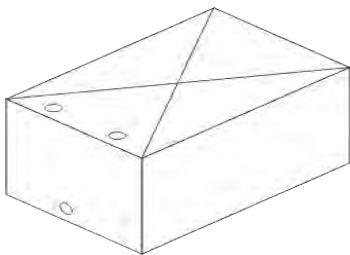

**J4624/300L** 300 Gallon (1363Ltr). (L) 1.83 x (W) 0.61 x (D) 1.22m.

**J4624/600L** 600 Gallon (2727Ltr). (L) 1.83 x (W) 1.22 x (D) 1.22m.

**J4624/1000L** 1000 Gallon (4546Ltr). (L) 2.44 x (W) 1.22 x (D) 1.53m.

## Fully Enclosed Bunded Steel Tanks

**J4645/300DS** 300 Gallon. (L) 1.98 x (W) 0.76 x (D) 1.22m.

**J4645/600DS** 600 Gallon. (L) 1.98 x (W) 1.37 x (D) 1.22m.

**J4645/1KDS** 1000 Gallon. (L) 2.59 x (W) 1.37 x (D) 1.53m.

## Tank Stands

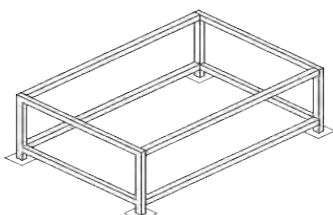

**J4300/24** For 300 Gallon tanks (2' high x 5' long x 2' wide).

**J4300/48** For 300 Gallon tanks (4' high x 5' long x 2' wide).

**J4600/24** For 600 Gallon tanks (2' high x 5' long x 4' wide).

**J4600/48** For 600 Gallon tanks (4' high x 5' long x 4' wide).



### Polyethylene Barrel Drip Tray

For health and safety, holds spillages.

**P0303** For 205Ltr barrels



### Drum Lift

**M8221** For ease of 205Ltr barrel tilting.



### Drum Oil Cover

**P0304** Black Plastic Top Tray for 205L Barrel



### Barrel Tilt & Stillage

Hard powder coat finish for 205Ltr barrels.

**A1091/ASE** 205 ltr drum tilt c/w wheels, handle and drain bowl

#### Optional Extras:

**A1099/1** Retaining strap.

**M8510** Single Barrel racking - no Wheels



### Barrel Wrench

**J2659** Universal (Not for petrol/volatile liquids).

**J2659/P** Plastic poly fibre.



### Tank Kit

- J6003** 3/4" BSP brass safety drain valve, vent fitting and filler fittings.
- J6005** 2" BSP cap and chain.



### Clock Gauges

1.1/2" BSP male.

- J4652** For 3' tanks.
- J4649** For 4' tanks.
- J4650** For 5' tanks.
- J4651** For 6' tanks.



### Barrel Level Gauge

- J4654** For 205Ltr barrels. 3/4" BSP.



### Push Button Sight Gauges

- J4646/PB** 4' x 1/2".
- J4672/PB** 6' x 1/2".



## Two-Wheeled Trolley with Support Arm

Robust trolley with 160 x 40mm wheels. Supports drum. See oil sections for suitable pumps.

**A1083/SLB** Fits all known 20-30Ltr containers with sliding 2" BSP bracket for pump.

**A1083SE** For use with J025V Valerex containers with drum support.

### Optional Extras:

**J025V** 25Ltr "Valerex" plastic container for use with A1083SE trolley.



## Two-Wheeled Trolley

Steel frame, hard powder coat finish, wide wheels. Folding handles for easy transportation.

**A1040** For round 20/25Ltr oil containers and 12.5kg grease kegs.

**A1094** For 60Ltr oil drums and 50/60kg grease kegs.



## Heavy Duty 4-Wheeled Barrel Trolley

Twin heavy duty wheels and twin castors. Brackets for securing barrel, hoses and pneumatic pumps.

**M4389** For transporting 180kg/205Ltr barrels with backplate for adding hose reel.

**M4388** For 180kg/205Ltr barrels without hose reel facility.

**P0306** Galvanised drip tray for above, 615 x 595 x 75mm.



## Drum Dollies

With castors and all fittings.

**A1044SE** For 180kg and 205Ltr oil drums. With 3" dia castors, one that is braked.





## 120Ltr Commercial Oil Drain Unit

With male fitting for "Clean" connection to pump away system. Clock gauge level indicator. 4-wheeled (2 rear castors). Min/max height 1190/1880mm.

**M8466SE** 30Ltr collection basin.



## 90Ltr Oil Drain Unit

Air pressure evacuation system. Can be left unattended during emptying. Max outlet hose length 2m. Min/max height 1150/1850mm.

**L3181E** 18Ltr round basin with 600mm dia extension bowl.



## 90Ltr Probe Extraction Drainers

18Ltr capacity basin with removable mesh. Six suction probes 800mm long, 2 steel (6 and 8mm), 4 flexible (5, 6, 7 and 8mm dia). Dual system - drain away or suction. Evacuation emptying by 2m hose that cannot be extended - pressure 2 bar max. Can be left unattended during emptying. Basin min/max height adjustment 1000/1700mm. Suction rate with hot oil (75°C) with 6mm probe, 15.2Ltr/min. BMW and Volkswagen adaptors.

**L3194** 18Ltr round basin with 600mm dia extension bowl.

**L3090** Specification as L3194 without basin.

### Optional Extras:

**M2997** 1200 x 7mm flexi probe.



## 80Ltr Oil Drain Unit

Air pressure evacuation system. Can be left unattended during emptying. Max outlet hose length 2m. Bowl min/max height 1160/1700mm.

**M3181E** 14Ltr Recovery basin.



## 80Ltr Pump Away Oil Drain Unit

M3181E Unit supplied with M2047 pump. Unit emptied in less than 4 mins.

**M3191E** 14Ltr Recovery basin.



## 80Ltr Probe Extraction Drainers

14Ltr capacity basin with removable mesh. Six suction probes 800mm long, 2 steel (6 and 8mm), 4 flexible (5, 5, 7 and 8mm dia). Dual system - drain away and suction. Evacuation emptying by 2m hose that cannot be extended - pressure 2 bar max. Can be left unattended during emptying. Basin min/max height adjustment 1160/1700mm. Suction time with hot oil (75° c) with 6mm probe, 15.2Ltr/min. Golf and Mercedes adaptors.

**M3194** 14Ltr Recovery basin. (Illustrated).

**M3080** As M3194 but without recovery basin.



## 80Ltr Hinged Basin/Probe Extension Drainers

Dual system - drain away arm or suction.

**M3182** 12Ltr Basin. Other specifications as M3194.

**M3180** 50Ltr Basin. Other specifications as M3194.



## 30Ltr Probe Extraction Unit

30Ltr container with 24Ltr probe suction capacity. Supplied with six suction probes. 6-8mm steel, 5, 6, 7 and 8mm flexible.

**M3024** Extraction Unit.



## Drain Bowls

With 2" BSP ratchet adaptor for easy adjustment with removable mesh tray.

- M3275/67** 25Ltr.
- M3275** 25Ltr without adaptor.
- M3290/67** 15Ltr.
- M3290** 15Ltr without adaptor.



## Air Operated Diaphragm Pump

See Chemicals & Fluid section for specification (page 36).

- P0210** 1/2" BSP Aluminium.
- P0211** 1" BSP Aluminium.



## Plastic Drain Bowls



- J2250** 14Ltr Black c/w handles and pourer.
- J2253** 6Ltr Red c/w pourer and filter rest.



## Waste Oil/Diesel/Anti-Freeze Air Operated Pump

Delivery 25Ltr/min, operating pressure 3-8 bar, outlet 3/4" BSP, supplied complete with wall bracket, 1.5m suction hose open ended.

- M2047SE** 1:1 Pump for use with storage and drainer systems.

**Accessories:** Outlet hose, end fittings.



### Vacuum Pump

Supplied complete with barrel fittings, 2.5m hose and suction nozzle, (38mm dia). This pump will collect liquid borne sludge, metal chips and other debris which often clog or wear out impeller-type pumps. Additionally, the pump will not lose its prime as the liquid level drops, eliminating the need to manually bail out the bottom of the sump.

- Precision made from stainless steel.
- Compressed air powered.
- Fast - Powerful action.
- No moving parts.
- Maintenance free.
- Safe.
- Automatic shut off valve when barrel full.
- High quality.
- Fast fill - 210Ltr in 90 seconds.

**J0020** For standard 205Ltr metal barrels.

### Performance Chart

Pressure	Psi	60	70	80	90	100
	Cfm	5.4	5.8	6	6.3	6.5
Air Consumption	M <sup>3</sup> /min	0.15	0.16	0.17	0.18	0.18
	In.Hg	7	7.8	8.5	9.5	10.1
Vacuum	mm.Hg	178	198	216	241	257
	Gal/min	29	33	34	37	38
Water	Ltr/sec	2.2	2.5	2.6	2.8	2.9
	Gal/min	25	27	30	33	34
Oil	Ltr/sec	1.9	2.1	2.3	2.5	2.6

**Caution: For best results:-**  
 Use filtered air 60 - 115 psi - 3/8" bore hose.  
 Use only with sound, undented steel barrels.  
**DO NOT** use with Volatile Fluids, Petrol, Kerosene etc.



### Mobile Decontaminating Oil Unit

Removes suspended particles from hydraulic systems or machinery lubrication where the circulating oil must be free of impurities.

- Self priming vane pump with by-pass.
- Flow rates from 25-30 Ltr/min.
- IP55 with thermal cut out.
- Filtration capacity 10 micron.
- Complete with transparent suction and discharge hoses.

**M3000** 230v.

**M3001** 110v.

**M3002** Replacement cartridge filter.



## Heavy Duty Tow Bar Pins

Supplied complete with heavy duty welded chain and lynch pin. Bright zinc plate and yellow passivate finish.

**Useable Length: 155mm**

**J1716** 16mm dia (5/8").

**J1720** 20mm dia (3/4").

**J1722** 22mm dia (7/8").

**J1724** 25mm dia (1").

**J1728** 28mm dia (1.1/8").

**J1732** 32mm dia (1.1/4").



## Linch Pins with 'D' Ring

Ring wire dia 3.5mm. Bright zinc plate and yellow passivate finish.

**J0250D** 6mm (1/4").

**J0312D** 8mm (5/16").

**J0437D** 11mm (7/16").



## Linch Pins with 'O' Ring

Ring wire dia 3.5mm. Bright zinc plate and yellow passivate finish.

**J0250** 6mm (1/4").

**J0312** 8mm (5/16").

**J7500** 10mm.

**J0437** 11mm (7/16").

**J3754** 9.5mm (54mm below head to inside ring) Bright Zinc.

**J3760** 9.5mm (3/8") dia with 60mm (i/d) ring.

**J3770** 9.5mm dia x 82mm with 70mm i/d ring



## Safety Linch Pin with 'O' Ring

**J7502** 8.7mm. 54mm useable length. Bright Zinc.

**J3770/SAF** 9.5mm. 70mm useable length. Yellow passivated.



## Linch Pin with Chain and 'S' Hook

J3770 Linch Pin with 12 link (27mm length) with 'S' hook

**A1011** 9.5mm.

### 'R' Grips

Single coil 'R' grips with bright zinc plate finish.

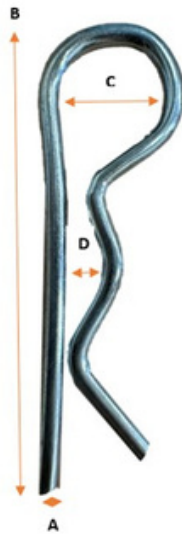

Product Code	Wire Dia.	Coil Dia.	Length
J0580	1.20mm	4mm	19mm
J0590	1.50mm	4mm	23mm
J0688	1.75mm	4mm	30mm
J0787	2.00mm	10mm	43mm
J0984	2.50mm	10mm	45mm
J1181	3.00mm	13mm	54mm
J1373	3.50mm	17mm	67mm
J1574	4.00mm	19mm	75mm
J1968	5.00mm	27mm	107mm
J2362	6.00mm	31mm	117mm
J2745	7.00mm	35mm	170mm
J3137	8.00mm	40mm	150mm

Note: J0580 is the standard brake pad 'R' grip.

### Double Coil 'R' Grips with Bright Zinc Plate Finish



Product Code	Wire Dia.	Coil Dia.	Length
J0787/2D	2.00mm	9.5mm	52mm



### Brass Straight Gate Valve

**P4104** 1/2"BSPTT (F/F) PN20

**P4105** 3/4"BSPTT (F/F) PN20

**P4106** 1"BSPTT (F/F) PN20

**P4108** 1.1/2"BSPTT (F/F) PN20

**P4109** 2"BSPTT (F/F) PN18



### Brass Angle Gate Valve

**J3068** 1"BSPTT (M/F) 90° PN20



### Nickel Plated Lever Ball Valve

**J7000/4** 1/2"BSPTT (F/F), not lever.

**P4204** 1/2"BSPTT (F/F) PN25

**P4205** 3/4"BSPTT (F/F) PN40

**P4206** 1"BSPTT (F/F) PN40



### Brass Swing Check Valve

**P4304** 1/2"BSPTT (F/F).

**P4305** 3/4"BSPTT (F/F).

**P4306** 1"BSPTT (F/F).



### Brass 'Y' Strainer

**P4504** 1/2"BSPTT (F/F) PN20

**P4505** 3/4"BSPTT (F/F) PN20

**P4506** 1"BSPTT (F/F) PN20



### Non-Return Valve with Filter

**P4606** 1"BSPTT (F)

**P4706** 1" Strainer only.

### Without Filter

**P4406** 1"BSPTT (F/F)



### Dry-Break Couplings

**J2251/F** 1/8" BSP (F)

**J2251/M** 1/8" BSP (M)

**J2252/CFF** 1/4" BSP (F) Chassis Filler

**J2252/CFM** 1/4" BSP (M) Chassis Filler

**J2254/F** 3/4" BSP (F)

**J2254/M** 3/4" BSP (M)

**J2258/F** 1" BSP (F)

**J2258/M** 1" BSP (M)



### Brass Hose Tail Chart



BSP									
1/4"	P2001	P2000	P2002	-	-	-	-	-	-
3/8"	P2009	P2010	-	P2011	-	-	-	-	-
1/2"	-	P2008	-	P2005	P2007	-	-	-	-
3/4"	-	-	-	P2013	P2012	P2015	-	-	-
1"	-	-	-	-	P2022	P2024	-	-	-
1.1/4"	-	-	-	-	-	-	P2028	-	-
1.1/2"	-	-	-	-	-	-	-	P2025	-
2"	-	-	-	-	-	-	-	-	P2030
Hose I/d	1/4"	3/8"	5/16"	1/2"	3/4"	1"	1.1/4"	1.1/2"	2"

### Galvanised Fittings



**P1104/G** 1/2"BSPTT (M/F) Galvanised M/F 90° elbow.

**P1105/G** 3/4"BSPTT (M/F) Galvanised M/F 90° elbow.

**P1106/G** 1"BSPTT (M/F) Galvanised M/F 90° elbow.

**P1109/G** 2"BSPTT (M/F) Galvanised M/F 90° elbow.



**P1302/G** 1/4"BSPTT (F/F) Galvanised Ribbed Socket.

**P1304/G** 1/2"BSPTT (F/F) Galvanised Ribbed Socket.

**P1305/G** 3/4"BSPTT (F/F) Galvanised Ribbed Socket.

**P1306/G** 1"BSPTT (F/F) Galvanised Ribbed Socket.



**P1504/G** 1/2"BSPTT (M/M) Galvanised Hexagon Nipple.

**P1505/G** 3/4"BSPTT (M/M) Galvanised Hexagon Nipple.

**P1506/G** 1"BSPTT (M/M) Galvanised Hexagon Nipple.

**P1509/G** 2"BSPTT (M/M) Galvanised Hexagon Nipple.



**P1705/G** 1/2" (M) x 1/4" (F) BSPTT Galvanised Hexagon Bush.

**P1714/G** 1" (M) x 1/2" (F) BSPTT Galvanised Hexagon Bush.

**P1715/G** 1" (M) x 3/4" (F) BSPTT Galvanised Hexagon Bush.

**P1734/G** 2" (M) x 1" (F) BSPTT Galvanised Hexagon Bush.